

The Chandelier from the Phantom of the Opera

The Chandelier in the Phantom of the Opera is one of the most complex technical pieces in a very complex production. The chandelier is usually supposed to look so amazing that it ends up literally weighing about 1,000 pounds. The chandelier starts on the stage, collapsed and covered with a tarp. After the prologue there is a pyrotechnic blast and then the lights on the chandelier flicker and the chandelier is raised up to the ceiling above the audience where it stays for the entire first act and then comes “crashing” back to the stage right before intermission. The chandelier lands on the stage (where there are actors) and the lights flicker and go out and then it also collapses into the pieces again.

The biggest issue for the Technical Director is safety. The chandelier has many pieces and it travels and stays over the audience then lands on the stage amidst a stage full of actors. The safety of everyone involved in and viewing the show has to be assured and that is no small feat in such a complex technical element.

There are many possible designs for the chandelier. I chose to write about the design that I found the best pictures of online (see Picture 1 & Picture 2).

Construction

The obvious first step is the construction of the chandelier itself. The design for most productions is based on old gas lamps because of the period of the Phantom of the Opera. Gas lamps have a central core area with layers of lamps attached. Each bulb is attached to the fixture and draped with hanging crystals much like the rest of the chandelier. For the Phantom of the Opera, the chandelier has to look as if it is broken

Melissa Cain
Technical Design Final Project

which usually means collapsed on the stage in the beginning so it has different layers that collapse into each other. The layers are connected by steel chain so when the chandelier is laying on the stage it is not supported and looks broken.

The chandelier is constructed of elliptical rings of 1/4" steel that are 2" tall. The rings would have to be ordered specially from a company to be the exact elliptical shapes. The outer diameter of the rings is from top: 8', 4', 10', 10', 6'. The rings are connected by 5/16" steel chain, except the two rings with 10' as the largest diameter are connected through a more rigid connection of welded steel tubing. The bottom of the 6' ring is welded to 1/2' steel pipe so that the pipe is the first part of the chandelier that hits the stage when the chandelier "crashes" into it. Each ring is supported internally by 11 gauge 1" square steel tubing welded to the outer steel rings. The structure of the supports can be seen on the drawings of the individual rings.

Decoration

The steel base is not seen at all when you look at the chandelier due to the massive amounts of decoration on top of the main structure. This decoration is very ornate and looks carved and due to the authenticity of the rest of the chandelier is probably made of thin iron or brass that is shaped around the rings as well as molded into the large ornate shapes that come off the main structure (see Photo 1). This will be bolted to the main steel rings and the bolts will be sealed with bolt-lock to ensure they do not move.

Crystal beads

Melissa Cain
Technical Design Final Project

The decoration contains thousands of crystal beads that are strung together and connect the steel rings. The crystal gives a dazzling effect, but could be very dangerous if one of the beads were to fall on an audience member. The crystal beads come attached and the biggest job will be to reinforce all the attachments, so there is no way they will come apart. The crystals and all of the chandeliers decorations will have to be checked nightly to make sure nothing comes loose. The risk of the crystal breaking is not very high as long as the lowering of the chandelier is controlled so that it does not literally come crashing down. Crystal is very strong and especially in bed form is able to withstand some impact before it shatters.

The Lights

There are 50 large globe lights on the chandelier that use antique style fixtures made of thin brass round stock. The fixtures are not large, but must be securely attached to the steel ring bases. The fixtures are very simple, but are made to break as little as possible. The brass fixtures attach to polycarbonate globes that cover shatter proof bulbs. There are also some crystals attached to the outside of the globes using very strong epoxy.

To avoid ruining the effect if one bulb were to break the bulbs chosen are ultra thick and made to last thousands of hours of use. The electrical wiring should be done in series, so if one bulb does burn out, the chandelier can still be quite magnificent.

The electrical cord connecting the chandelier to power will have to be able to reach from the stage all the way up to the ceiling and back down again. Pulling up the electrical cord and letting it out will mostly likely have to be done manually to ensure that

Melissa Cain
Technical Design Final Project

none of the connections break or get tangled with the rigging equipment. The electricity should also have an emergency cut off in case anything seems to be wrong so that no one on stage is hurt.

Rigging System

The movement of the chandelier is controlled by two cables. A loft block supports one cable directly over the position on the stage where the chandelier is located for the prologue. The other cable is supported by a loft block located above the point where the chandelier will rest in the air above the audience. These locations allow for one cable and winch to support all the weight of the chandelier when it is not in motion. This also means that each cable must be able to support the full weight of the chandelier.

The most difficult part of the rigging system will be timing the two separate cables so that they lift at the same time and create quick and smooth rise of the chandelier up to the ceiling and back down again. A system of this complexity would necessarily have to be controlled using automated controls, which would have more flexibility and precision and would be easier to monitor than manual controls. In fact, because it is possible to move one cable too quickly and land the whole chandelier in the audience it is impossible to rely on human error in such a situation, so a machine with very specific controls

The cables would travel from the chandelier to a loft block and would then perhaps be easiest controlled by a drum winch without the use of counterweights, so the winch supports all of the weight.

Melissa Cain
Technical Design Final Project

The two cables also effectively give the system a back up if one fails for some reason. The effect would not work if one of the cables fell, but each is strong enough to hold the chandelier by itself and either could be operated independently of the computer system to ensure that there is no danger to the audience.

I am not sure if the cables are connected after the chandelier falls to the stage at the end of the first act, but I think that after that point the chandelier rises back into place above the audience as if it were fixed during intermission. However, I am not sure of that. To handle the extreme load the best choice for the cable is 3/8" aircraft cable.

Drum winch

The most widely used motorized winch has a single drum long enough to accommodate all of the lift lines required for the set. The drum is helically grooved so that the lift lines wrap neatly in a single layer, to avoid damage to the wire rope and to keep all lines lifting evenly. Loft blocks are used to route the cable to the batten.

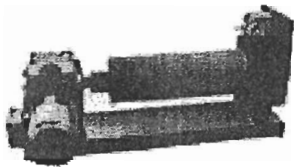

This is a picture of a drum winch similar to the ones that would be used in this system.

Control System

The control system suggested to operate a complicated rigging system in a venue that Phantom of the Opera is usually performed is the Nomad Multi-User Control system.

Flash pot

For the explosion effect that takes place at the beginning of the play it is easiest to use a simple Flashpot. Depending on the Director's view a flashpot can be loaded with a wide range of effects. For Phantom of the Opera everything is large than life so I think it would make sense to have both smoke and a flash of light and maybe sound depending on how deafening it would be in the performance area.

In any case safety is the most important factor to look at when dealing with pyrotechnics so there are many safety precautions that will need to be followed to use any kind of effect. Such as everything anywhere near the device being entirely flame resistant and actors must be aware of the dangers and not too close to the blast to cause damage. A wireless controller is probably best suited for Phantom, but the operator must be able to see the device at all times to make sure it is safe to activate it.

Attachments

1. Cost Analysis

Steel Chain

Size: 3/8"

Links per Foot: 9 3/4

Proof Test: 3720 lbs.

Approximate Safe Working Load: 1860 lbs.

Price: \$19.46/ft

Weight: 1.4 lbs/ft

Need: 7ft

Weight: 9.8 lbs.

Total Price: \$136.22

Steel Rings

Melissa Cain
Technical Design Final Project

Size: 1/4" plate
Weight: 10.21 lb/ft²
Will have to be specially ordered because of the shape, so will probably cost around
\$5000.00

Steel bracing
Size: 1"
Gauge: 11
Weight: 1.358 lbs/ft
Price: \$4.75/ft
Amount: 190 ft
Total Weight: 258.02 lb.
Total Price: \$902.50

Brass Round (464)
Size: 1/4" Diameter
Price: \$3.48/lb
Weight: 2 1/3 lb/12ft
Amount: 60 ft (11 2/3 lbs)
Cost: \$40.60

Brass Sheets
Thickness: 0.032"
Size: 3'X8'
Weight: 35 lb/sheet
Price: \$3.94/lb
Price per sheet:
Amount: 400 ft² (17 sheets)
Cost: \$2344.30

Polycarbonate Globes
Price: \$4.50
Quantity: 50 (well 75 to play it safe)
Cost: \$225.00 (\$337.50)

Shatter proof Light Bulbs
Price: \$2.75
Number: 50(75)
Total Cost: \$137.50 (\$206.25)

Crystal Prism Strand
Price: \$6.00/yd
Amount: 1000 yd
Total Cost: \$6000.00
Weight: Approx. .25 lbs/yd
Total weight: 25 lbs.

Melissa Cain
Technical Design Final Project

Crystal U-drop
Price: \$0.40/each
Amount: 1000
Total Cost: \$400.00

Aircraft Cable
Preformed Stainless Steel Aircraft Cable Flexible Type 302/304
Price: \$0.90/ft
Amount: 500 ft (depends on height of theater)
Weight: 24.3 lbs/100 ft
Total Weight: 121.5 lbs
Total Cost: \$450.00

Flash Pod
Price: \$45.00
Quantity: 1

Flash Cartridge
Price: \$49.00/dozen
Quantity: depends on the run of the show

2. Winch Specifications (the whole rigging system is too complicated to price out, but these are some features that a winch for this job would contain)

Slack Line Detector

This device detects slack lift lines and/or lines with below minimum tension and stops the winch. Several styles of mechanical and/or electronic detectors are available.

Crossed Groove Detector

This device stops the winch in the event that a lift line crosses over a groove or another lift line as it winds onto the drum.

Traveling Drum

Zero fleet angle winches use drums that move so the takeoff point of the lift lines remains constant as the drum turns. This is useful when there is insufficient distance between the drum and the first block to permit a proper fleet angle.

Secondary Brakes

Secondary brakes operate on the load side of the gearbox. They provide back up protection against failures in the controls, primary brake or gearmotor. The brake suggested for this application is an overspeed brake. The overspeed brake is directly coupled to the shaft driving the winch drum, the overspeed brake engages automatically if a preset speed is exceeded. The unit works on centrifugal forces, bringing the winch to

Melissa Cain
Technical Design Final Project

a controlled stop in the event of an overspeed condition. This fully automatic brake functions without any power or external control system.

3. Visual Stimuli

Picture 1

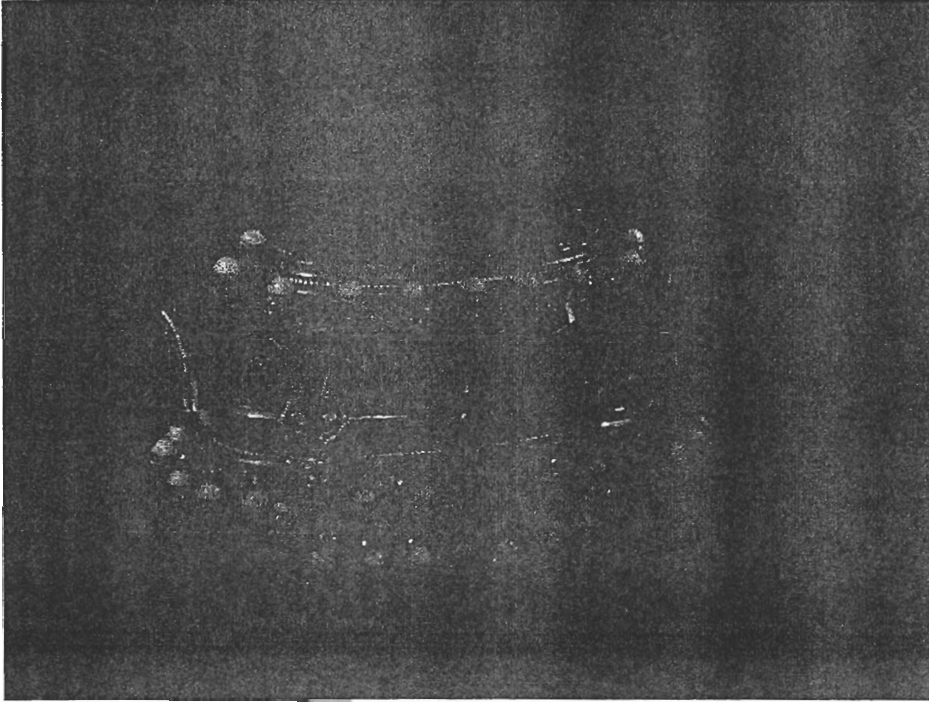

This is a picture of the chandelier very close to the stage in all it's glory. This was the main inspiration for the design used in this project.

Picture 2

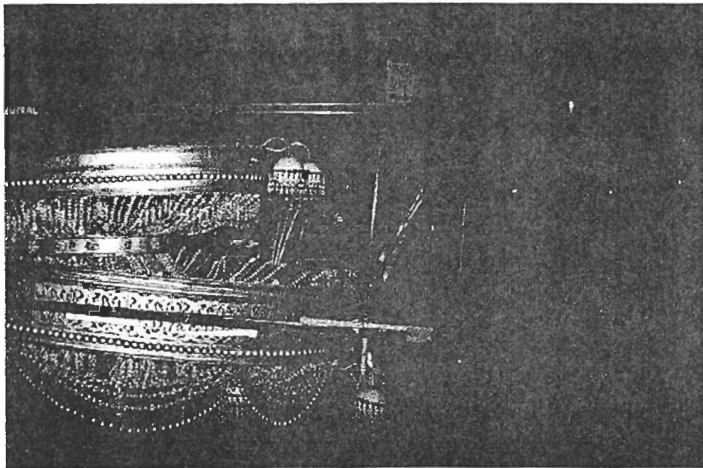

This is a picture of the chandelier being stowed away for shipping and shows its ability to collapse.

Melissa Cain
Technical Design Final Project

References

Crystal

<http://www.gspncrystals.com/chandelierandchristmastreecr.htm>

Bulbs

<http://www.bulbs.com>

Pictures

http://www.mehras.net/08_16_new_york_city/v_theater_chandelier.JPG

Pyrotechnics

<http://www.starmgc.com/pyroc.html>

Rigging

www.jrclancy.com

Aircraft Cable

www.webriggingsupply.com

Steel

http://www.askzn.co.za/jaguar_products.htm

Chain

<http://bosunsupplies.com/products2.cfm?product=S0602>

Brass

www.farmers-copper.com

Statistics for Phantom Chandelier

<http://www.geocities.com/Broadway/2403/phanfact.html>

Polycarbonate Covers

http://home.flash.net/~holdrman/patio_lights/string.html

Overall design and construction

Carter, Paul. The Backstage Handbook, Broadway Press. Louisville, KY. 1994.

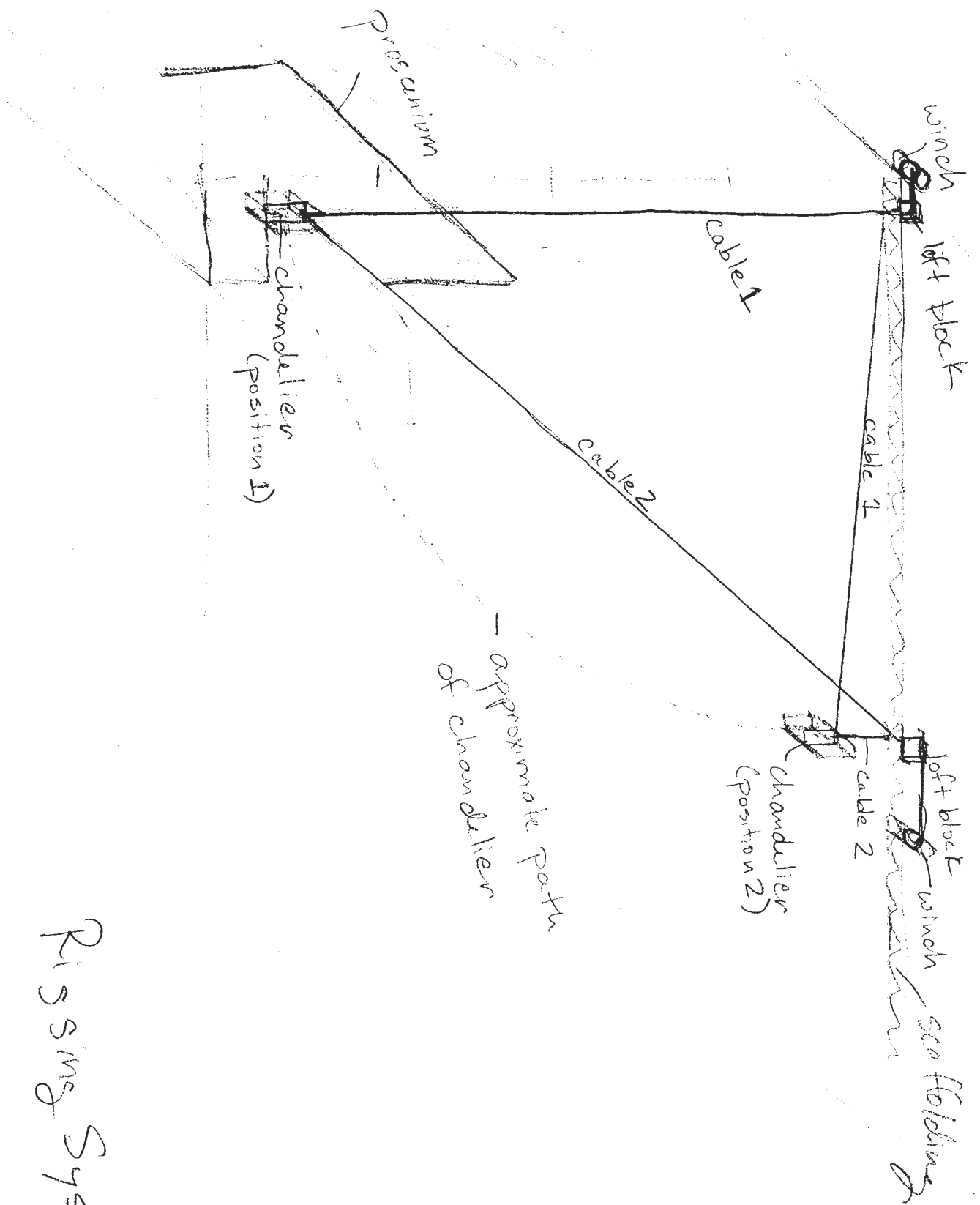

Rigging System

Light as evenly spaced as possible. Calculating the circumference of an ellipse is almost impossible so 15ths should be positioned approx. on the "X"s

Equation of the ellipse:

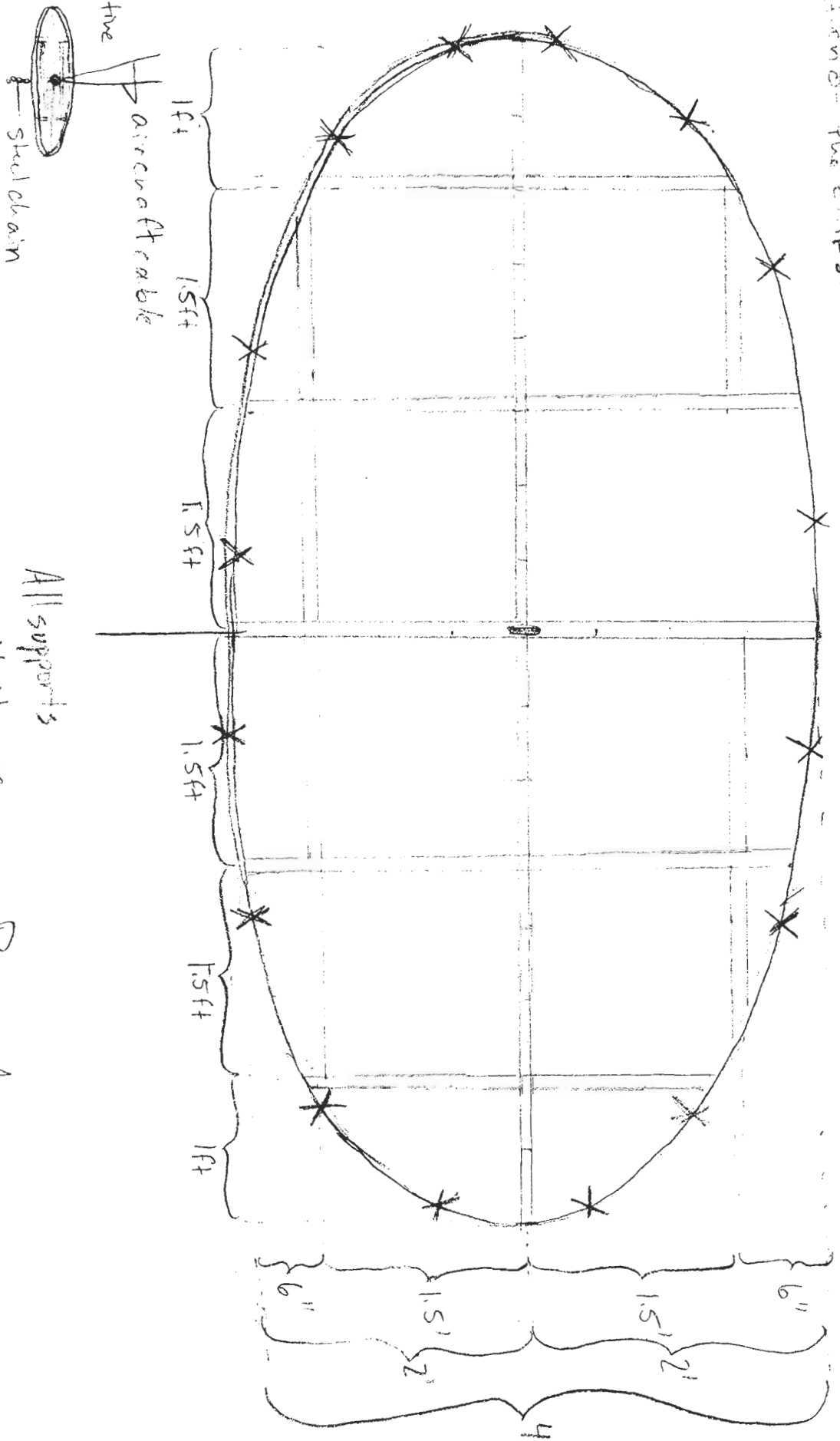

All supports

are 1" square steel square tubing

Ring Plan

inches

Ring 2

There are no lights on the small rings

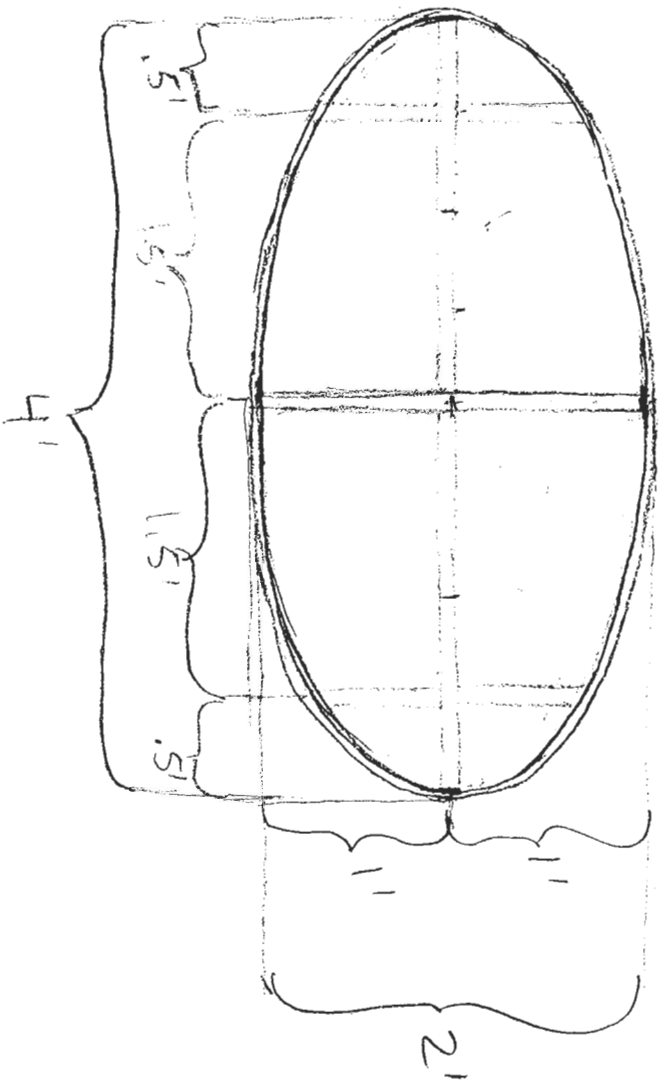

Melissa Cain

Rings 3+4

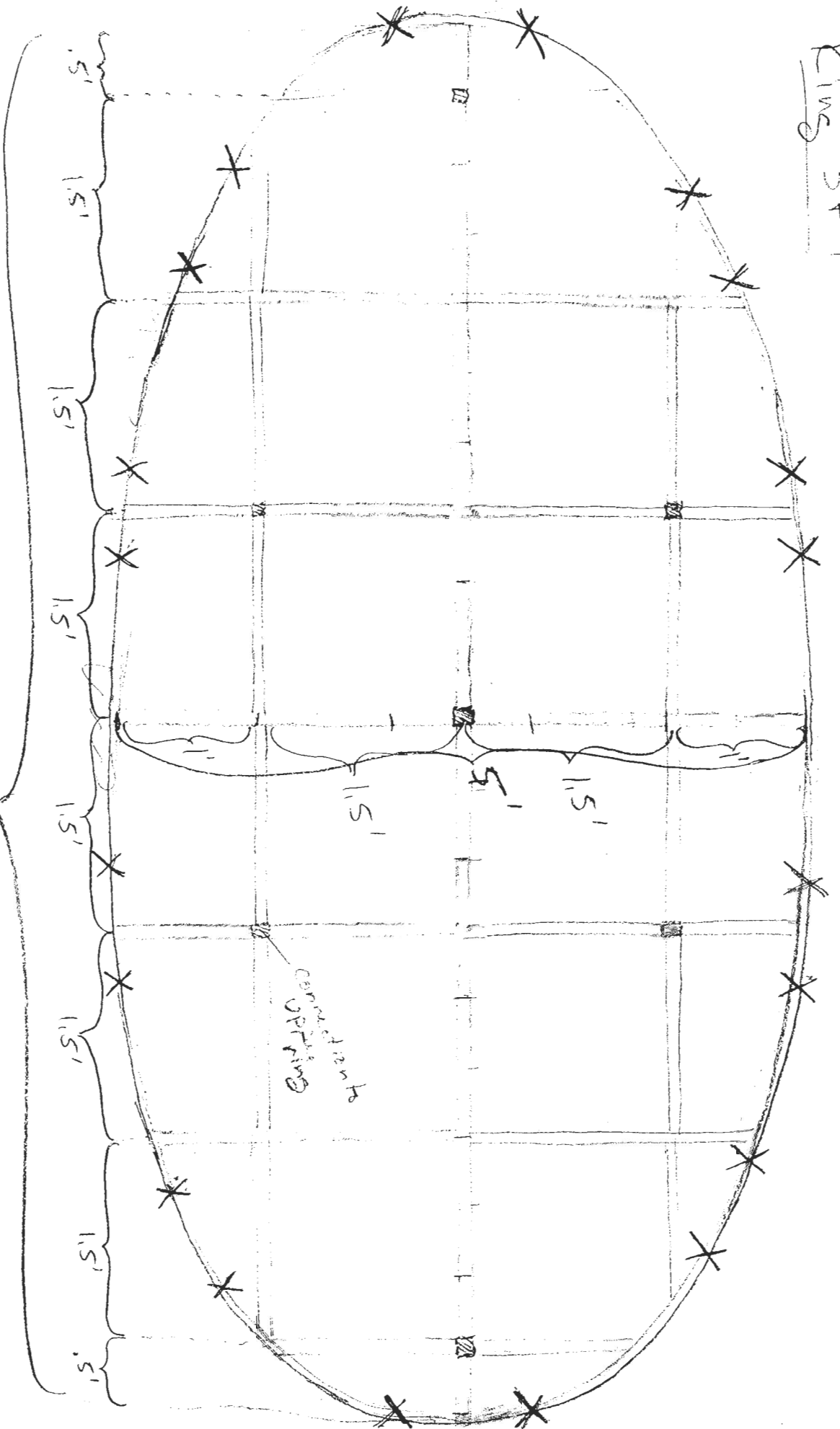

This ring connects to upper rings with same structure, but no lights
20 lights on this ring.

Plan mals...

Rings

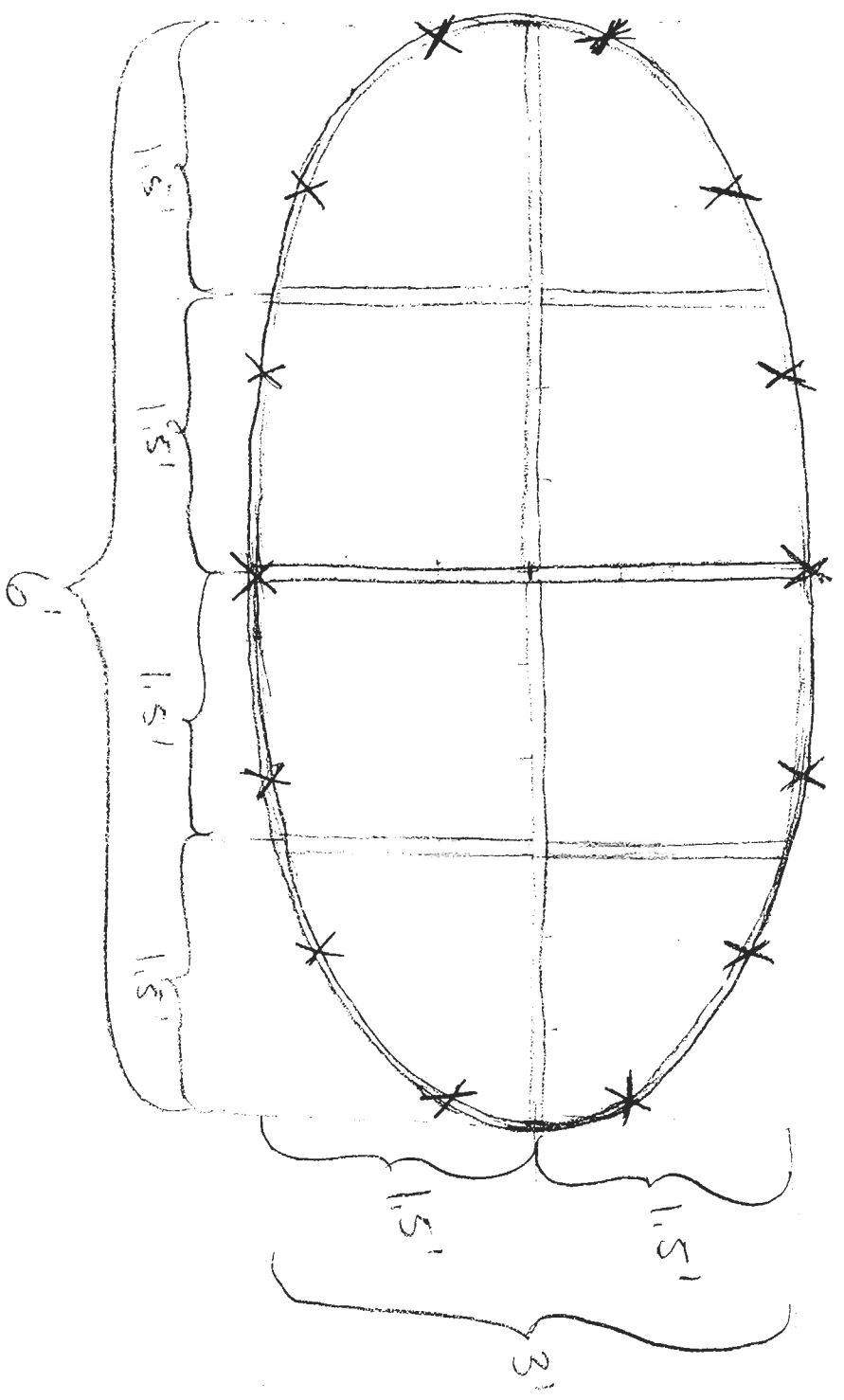

This ring is welded to a 1" steel box like the ones used for the bracing

