

MIT OpenCourseWare
<http://ocw.mit.edu>

6.004 Computation Structures
Spring 2009

For information about citing these materials or our Terms of Use, visit: <http://ocw.mit.edu/terms>.

Virtual Memory

You heard me right, kid.
TERABYTES of main
memory!

Quiz #3 Tomorrow!

Lessons from History...

There is only one mistake that can be made in computer design that is difficult to recover from—not having enough address bits for memory addressing and memory management.

Gordon Bell and Bill Strecker
speaking about the PDP-11 in 1976

A partial list of successful machines that eventually starved to death for lack of address bits includes the PDP 8, PDP 10, PDP 11, Intel 8080, Intel 8086, Intel 80186, Intel 80286, Motorola 6800, AMI 6502, Zilog Z80, Cray-1, and Cray X-MP.

Hennessy & Patterson

Why? Address size determines minimum width of anything that can hold an address: PC, registers, memory words, HW for address arithmetic (BR/JMP, LD/ST). When you run out of address space it's time for a new ISA!

Top 10 Reasons for a BIG Address Space

10. Keeping Micron and Rambus in business.
9. Unique addresses within every internet host.
8. Generating good 6.004 quiz problems.
7. Performing 32-bit ADD via table lookup
6. Support for meaningless advertising hype
5. Emulation of a Turing Machine's tape.
4. Bragging rights at geek parties.
3. **Isolating ISA from IMPLEMENTATION**
 - details of HW configuration shouldn't enter into SW design
2. **Usage UNCERTAINTY**
 - provide for run-time expansion of stack and heap
1. **Programming CONVENIENCE**
 - create regions of memory with different semantics: read-only, shared, etc.
 - avoid annoying bookkeeping

Squandering Address Space

Address Space

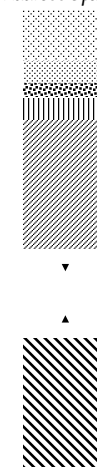

CODE, large monolithic programs (eg, Office, Netscape)....

- only small portions might be used
- add-ins and plug-ins
- shared libraries/DLLs
-

STACK: How much to reserve? (consider RECURSION!)

OBSERVATIONS:

- Can't BOUND each usage... without compromising use.
- Actual use is SPARSE
- Working set even MORE sparse

HEAP: N variable-size data records...
Bound N? Bound Size?

Extending the Memory Hierarchy

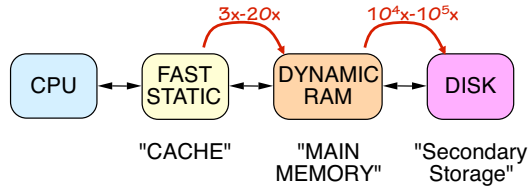

So, we've used SMALL fast memory + BIG slow memory to fake BIG FAST memory.

Can we combine RAM and DISK to fake DISK size at RAM speeds?

VIRTUAL MEMORY

- use of RAM as cache to much larger storage pool, on slower devices
- TRANSPARENCY - VM locations "look" the same to program whether on DISK or in RAM.
- ISOLATION of RAM size from software.

Virtual Memory

ILLUSION: Huge memory (2^{32} bytes? 2^{64} bytes?)

ACTIVE USAGE: small fraction (2^{24} bytes?)

HARDWARE:

- 2^{30} (1 G) bytes of RAM
- 2^{37} (128 G) bytes of DISK...
- ... maybe more, maybe less!

ELEMENTS OF DECEIT:

- Partition memory into "Pages" (2K-4K-8K)
- MAP a few to RAM, others to DISK
- Keep "HOT" pages in RAM.

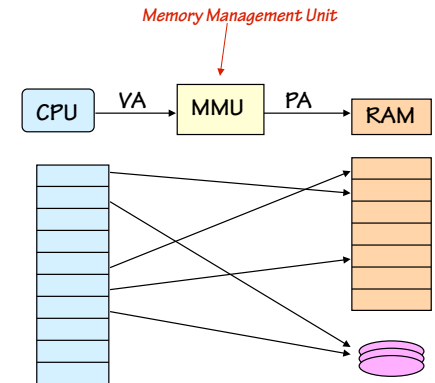

Demand Paging

"Bean - get in here immediately! And bring a mop!"

Basic idea:

- Start with all of VM on DISK ("swap area"), MMU "empty"
- Begin running program... each VA "mapped" to a PA
 - Reference to RAM-resident page: RAM accessed by hardware
 - Reference to a non-resident page: traps to software handler, which
 - Fetches missing page from DISK into RAM
 - Adjusts MMU to map newly-loaded virtual page directly in RAM
 - If RAM is full, may have to replace ("swap out") some little-used page to free up RAM for the new page.
- Working set incrementally loaded, gradually evolves...

Simple Page Map Design

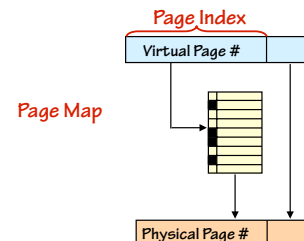

FUNCTION: Given Virtual Address,

- Map to PHYSICAL address
- OR
- Cause PAGE FAULT allowing page replacement

Why use HIGH address bits to select page?
... LOCALITY.
Keeps related data on same page.

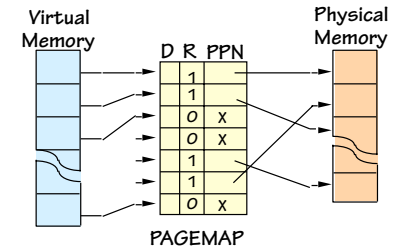

Virtual Memory vs. Cache

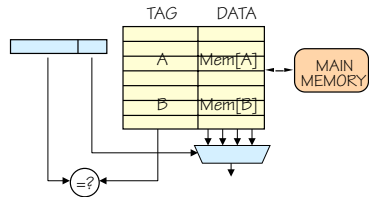

Cache:

- Relatively short blocks
- Few entries: scarce resource
- miss time: 3x-20x hit times

Virtual memory:

- disk: long latency, fast xfer
 - miss time: $\sim 10^5$ x hit time
 - write-back essential!
 - large pages in RAM
- lots of entries: one for each page
- tags in page map, data in physical memory

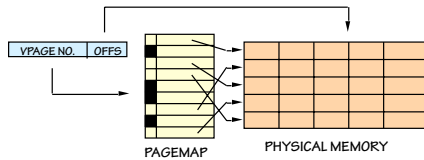

Virtual Memory: the VI-1 view

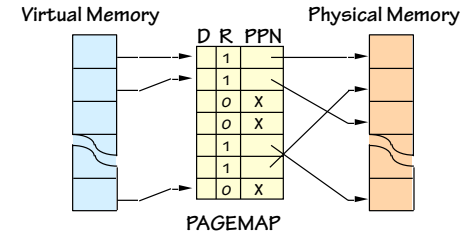

Pagemap Characteristics:

- One entry per **virtual** page!
- RESIDENT bit = 1 for pages stored in RAM, or 0 for non-resident (disk or unallocated). Page fault when R = 0.
- Contains PHYSICAL page number (PPN) of each resident page
- DIRTY bit says we've changed this page since loading it from disk (and therefore need to write it to disk when it's replaced)

Virtual Memory: the VI-3 view

Problem: Translate VIRTUAL ADDRESS to PHYSICAL ADDRESS

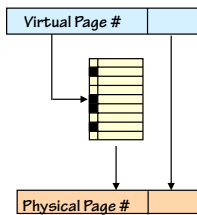

```
int VtoP(int VPageNo, int PO) {
    if (R[VPageNo] == 0)
        PageFault(VPageNo);
    return (PPN[VPageNo] << p) | PO;
}
// Multiply by 2^p, the page size

/* Handle a missing page... */
void PageFault(int VPageNo) {
    int i;

    i = SelectLRUPage();
    if (D[i] == 1)
        WritePage(DiskAdr[i], PPN[i]);
    R[i] = 0;

    PPN[VPageNo] = PPN[i];
    ReadPage(DiskAdr[VPageNo], PPN[i]);
    R[VPageNo] = 1;
    D[VPageNo] = 0;
}
```

The HW/SW Balance

IDEA:

- devote HARDWARE to high-traffic, performance-critical path
- use (slow, cheap) SOFTWARE to handle exceptional cases

```
hardware {
    int VtoP(int VPageNo, int PO) {
        if (R[VPageNo] == 0) PageFault(VPageNo);
        return (PPN[VPageNo] << p) | PO;
    }
}

software {
    /* Handle a missing page... */
    void PageFault(int VPageNo) {
        int i = SelectLRUPage();
        if (D[i] == 1) WritePage(DiskAdr[i], PPN[i]);
        R[i] = 0;

        PA[VPageNo] = PPN[i];
        ReadPage(DiskAdr[VPageNo], PPN[i]);
        R[VPageNo] = 1;
        D[VPageNo] = 0;
    }
}
```

HARDWARE performs address translation, detects page faults:

- running program interrupted ("suspended");
- PageFault(...) is forced;
- On return from PageFault; running program continues

Page Map Arithmetic

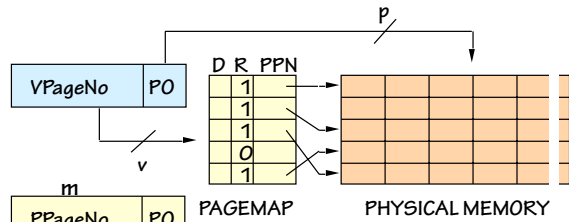

Wait... if v equals m, why have a pagemap at all?

- $(v + p)$ bits in virtual address
- $(m + p)$ bits in physical address
- 2^v number of VIRTUAL pages
- 2^m number of PHYSICAL pages
- 2^p bytes per physical page
- 2^{v+p} bytes in virtual memory
- 2^{m+p} bytes in physical memory
- $(m+2)v$ bits in the page map

Typical page size: 1K - 8K bytes
 Typical $(v+p)$: 32 (or more) bits
 Typical $(m+p)$: 30 - 32 bits
 (1G - 4G)

Example: Page Map Arithmetic

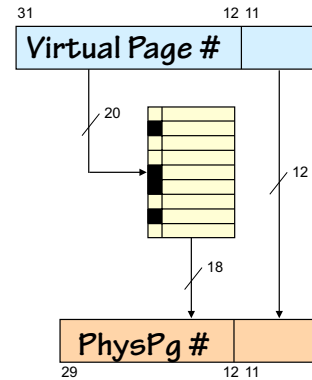

SUPPOSE...

- 32-bit Virtual address
- 2^{12} page size (4 KB)
- 2^{30} RAM max (1 GB)

THEN:

- # Physical Pages = $2^{18} = 256K$
- # Virtual Pages = 2^{20}
- # Page Map Entries = $2^{20} = 1M$
- # Bits In pagemap = $20 * 2^{20} \approx 20M$

Use SRAM for page map??? OUCH!

RAM-Resident Page Maps

SMALL page maps can use dedicated RAM... gets expensive for big ones!

SOLUTION: Move page map to MAIN MEMORY:

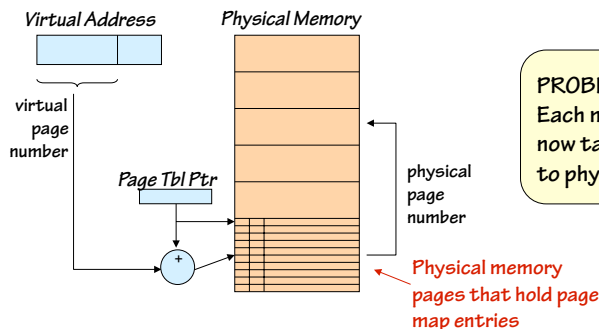

PROBLEM:
 Each memory reference now takes 2 accesses to physical memory!

Translation Look-aside Buffer (TLB)

PROBLEM: 2x performance hit... each memory reference now takes 2 accesses!

SOLUTION: CACHE the page map entries

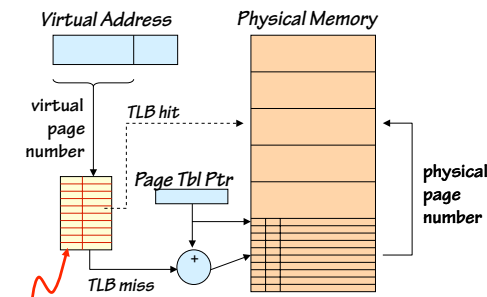

TLB: small, usually fully-associative cache for mapping VPN → PPN

IDEA:
 LOCALITY in memory reference patterns → SUPER locality in reference to page map

VARIATIONS:

- sparse page map storage
- paging the page map!

Example: mapping VAs to PAs

Suppose

- virtual memory of 2^{32} bytes
- physical memory of 2^{24} bytes
- page size is 2^{10} (1 K) bytes

VPN	R	D	PPN
0	0	0	7
1	1	1	9
2	1	0	0
3	0	0	5
4	1	0	5
5	0	0	3
6	1	1	2
7	1	0	4
8	1	0	1
...			

1. How many pages can be stored in physical memory at once? $2^{24-10} = 2^{14}$
2. How many entries are there in the page table? 2^{22}
3. How many bits are necessary per entry in the page table? (Assume each entry has PPN, resident bit, dirty bit) 16
4. How many pages does the page table require? $2^{23} \text{ bytes} = 2^{13} \text{ pages}$
5. What's the largest fraction of VM that might be resident? $1/2^8$
6. A portion of the page table is given to the left. What is the physical address for virtual address $0x1804$?

$VPN=6 \rightarrow PPN=2 \rightarrow PA=0x804$

Contexts

A **context** is a mapping of VIRTUAL to PHYSICAL locations, as dictated by contents of the page map:

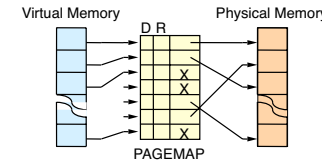

Several programs may be simultaneously loaded into main memory, each in its separate context:

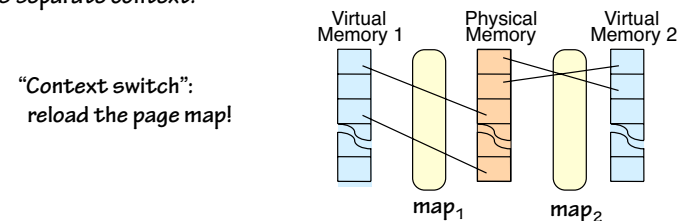

Contexts: A Sneak Preview

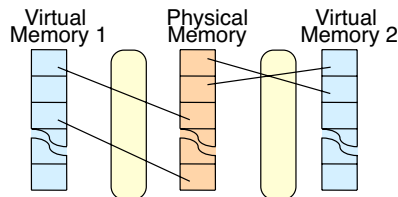

Every application can be written as if it has access to all of memory, without considering where other applications reside.

First Glimpse of a VIRTUAL MACHINE

1. **TIMESHARING** among several programs --
 - Separate context for each program
 - OS loads appropriate context into pagemap when switching among pgms
 2. Separate context for OS "Kernel" (eg, interrupt handlers)...
 - "Kernel" vs "User" contexts
 - Switch to Kernel context on interrupt;
 - Switch back on interrupt return.
- HARDWARE SUPPORT: 2 HW pagemaps**

Rapid Context Switching

Add a register to hold index of current context. To switch contexts: update Context # and Page Tbl Ptr registers. Don't have to flush TLB since each entry's tag includes context # in addition to virtual page number

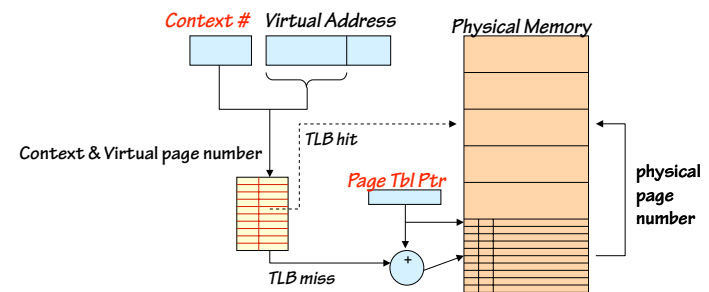

Using Caches with Virtual Memory

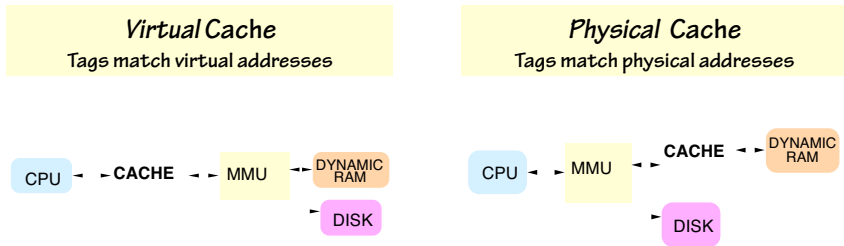

- Problem: cache invalid after context switch
- FAST: No MMU time on HIT
- Avoids stale cache data after context switch
- SLOW: MMU time on HIT

Best of both worlds

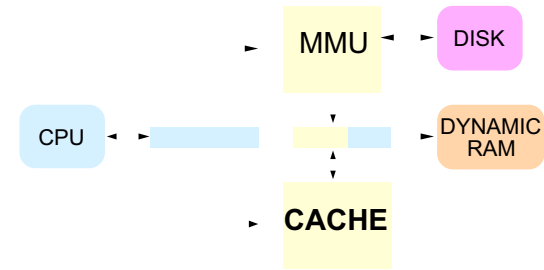

OBSERVATION: If cache line selection is based on unmapped page offset bits, RAM access in a physical cache can overlap page map access. Tag from cache is compared with physical page number from MMU.

Want "small" cache index → go with more associativity

Alternative memory structures?

Maybe we're hung up on the simple "address space" model. Some alternatives:

- Segments: named contiguous regions (Multics, x86, ...)
- Objects: Cons cells, arrays, ... (LISP machines, 432,)
- URIs (web)
- Triples/relations (LEAP, SAIL, RDF, ...)
- Associations
- Etc etc etc

All of these, and more, have been tried - with occasional success. But for the most part, we gravitate to that most venerable of Computer Science traditions:

Take a familiar model (viz, RAM).
Virtualize it.

Summary

Exploiting locality on a large scale...

- Programmers want a large, flat address space...
... but they'll use it sparsely, unpredictably!
- Key: Demand Page sparse working set into RAM from DISK
- IMPORTANT: Single-level pagemap, arithmetic, operation...
 - Access loaded pages via fast hardware path
 - Load virtual memory (RAM) on demand: page faults
- Various optimizations...
 - Moving pagemap to RAM, for economy & size
 - Translation Lookaside Buffer (TLB), to regain performance
 - Moving pagemap to DISK (or, equivalently, VM) for economy & size
- Cache/VM interactions: can cache physical or virtual locations

Semantic consequence:

- CONTEXT: a mapping between V and P addresses - we'll see again!

Challenge: Alternative models

- Will we just use bigger addresses when we outgrow our current ISAs?