

(a) Symmetry = 4

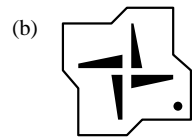

(c) Two addition rules

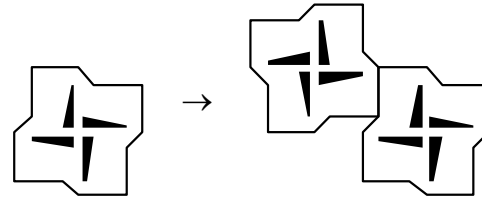
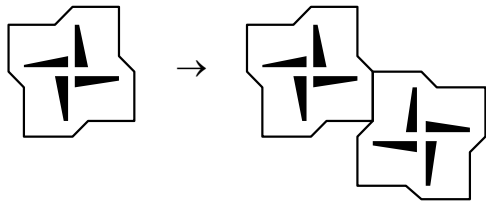

(d) Four basic (labeled) rules

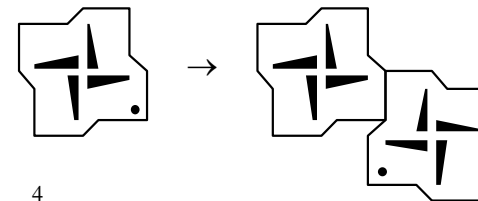
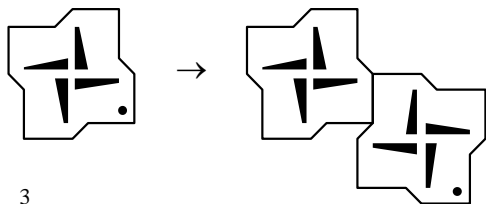
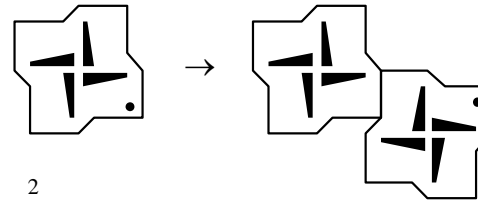
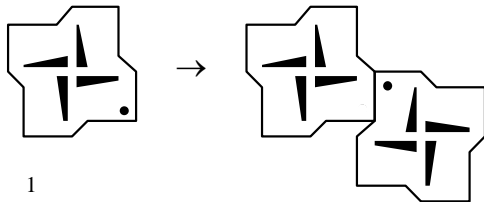

(e) Designs generated by the rules in(d)

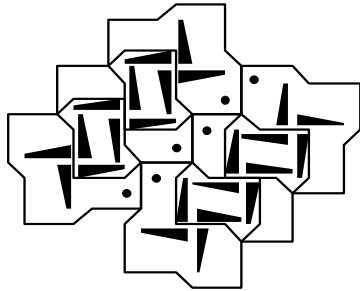

1

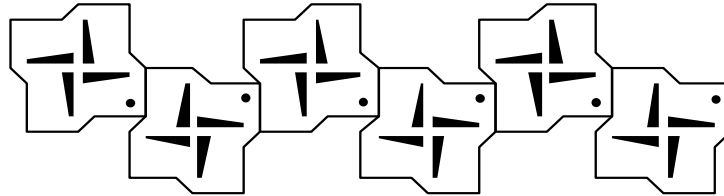

2

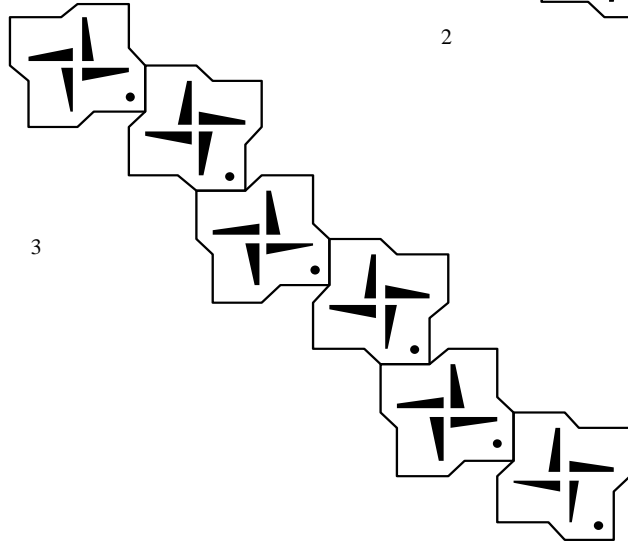

3

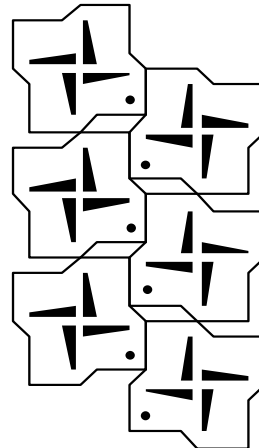

4

Hierarchy of shape grammars

basic grammars

nondeterministic basic grammars

additive grammars

unrestricted grammars

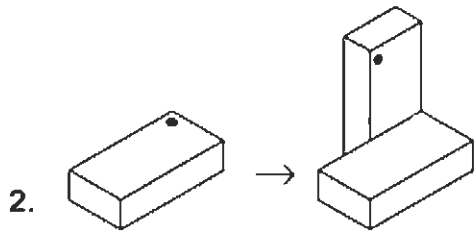
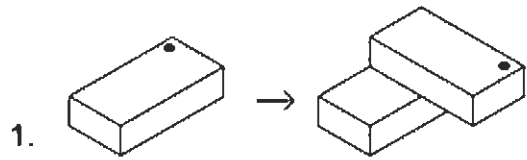

basic grammar

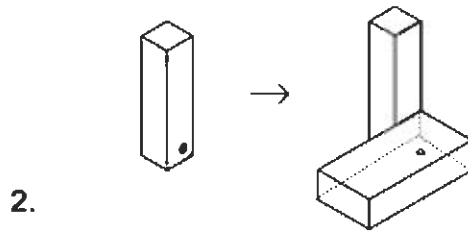
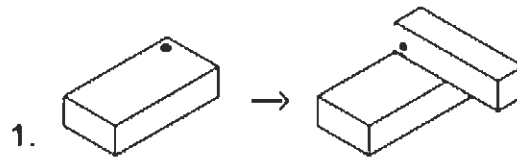

basic grammar

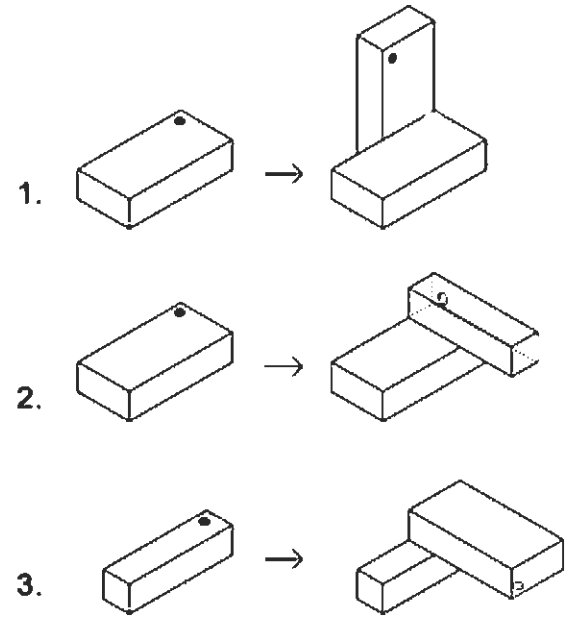

basic grammar

BASIC GRAMMARS
different spatial relations

Hierarchy of shape grammars

basic grammars

❖ nondeterministic basic grammars

additive grammars

unrestricted grammars

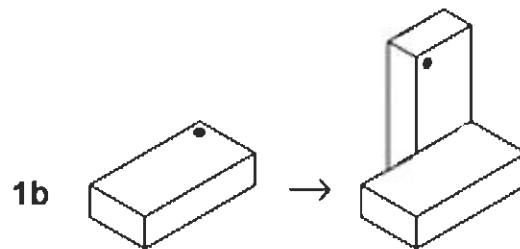
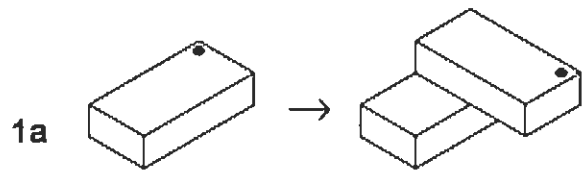

1a 1b

ND basic grammar

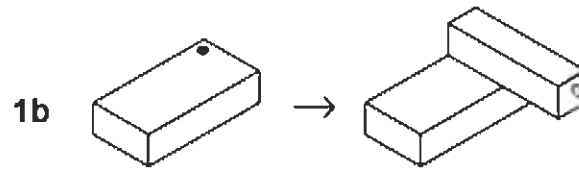
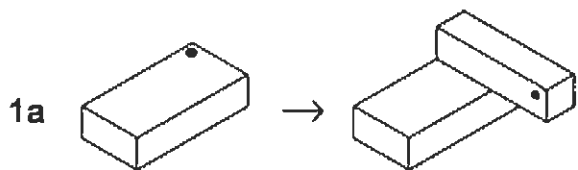

1a 1b

 2

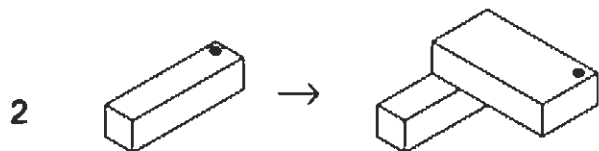

ND basic grammar

NONDETERMINISTIC BASIC GRAMMARS

Hierarchy of shape grammars

basic grammars

nondeterministic basic grammars

❖ additive grammars

unrestricted grammars

Additive grammar

A set of addition rules

Initial shape: any shape labeled in any way

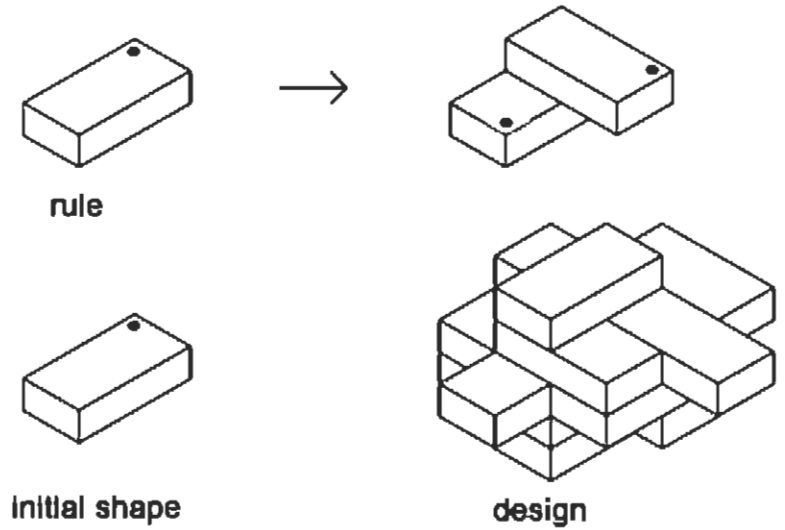
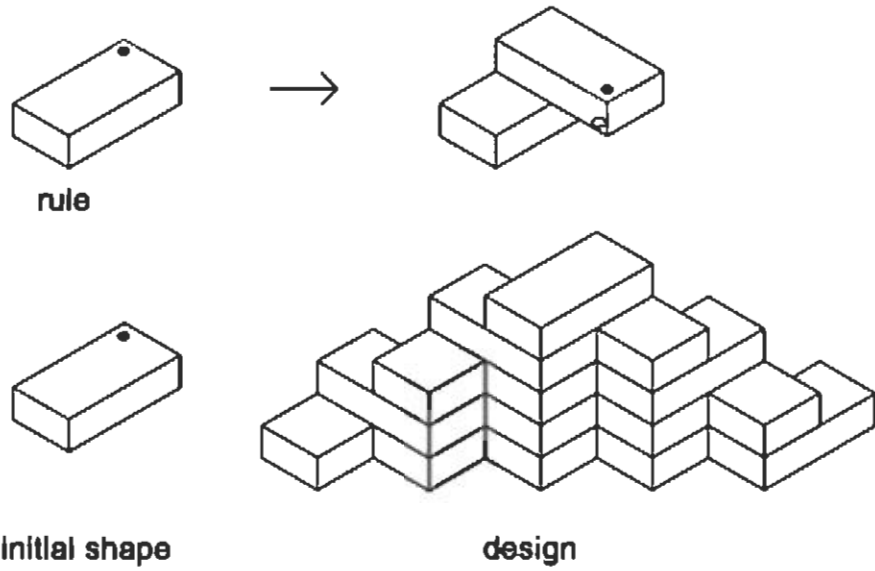

ADDITIVE GRAMMARS
rules with multiple labels

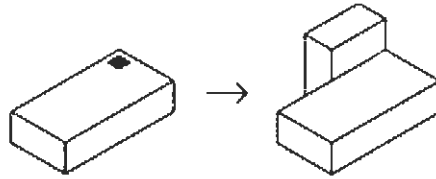
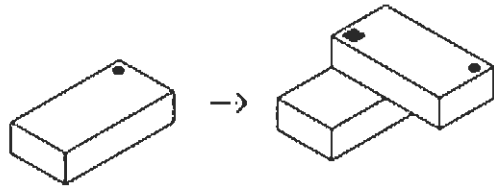

rules

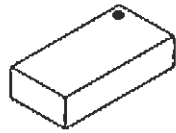

initial shape

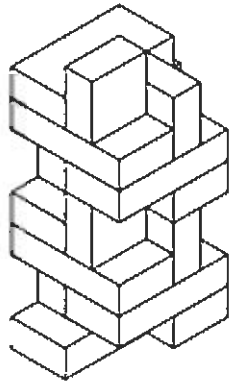

design

**ADDITIVE GRAMMAR
ornamentation rule**

basic rule

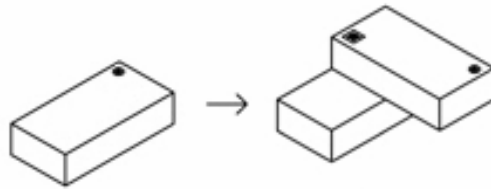

ornament rule

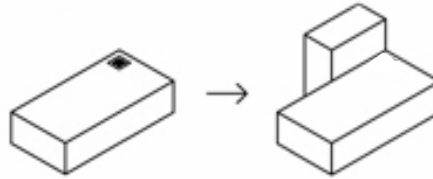

rules

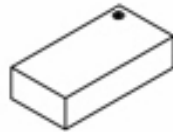

initial shape



design

ADDITIVE GRAMMAR
ornamentation rule

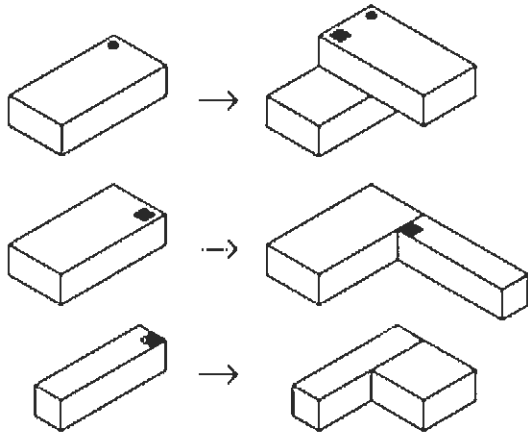

rules

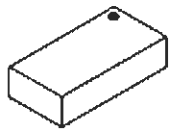

initial shape

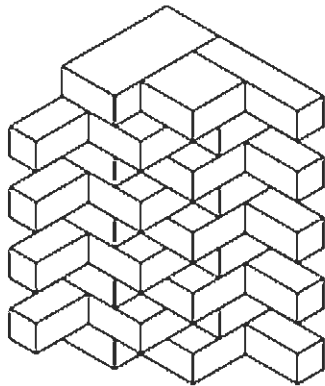

design

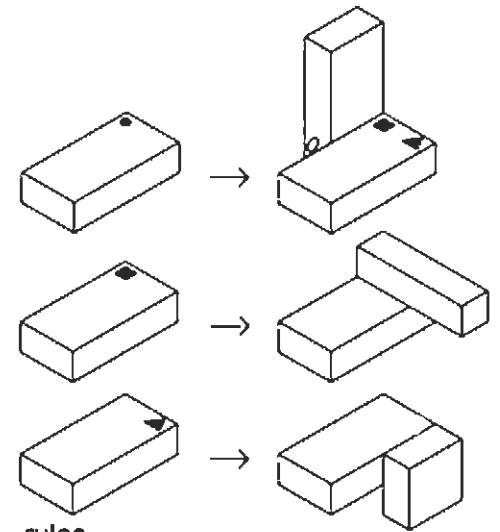

rules

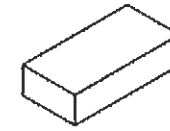

initial shape

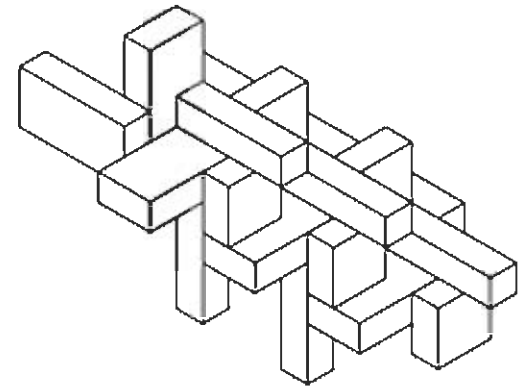

design

ADDITIVE GRAMMARS
ornamentation rules

basic rule

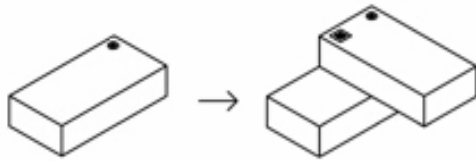

ornament rules

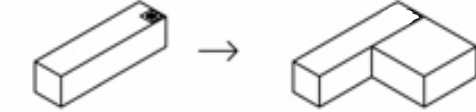
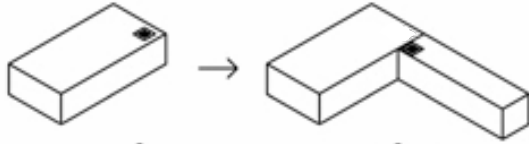

rules

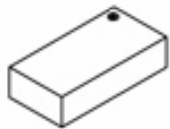

initial shape

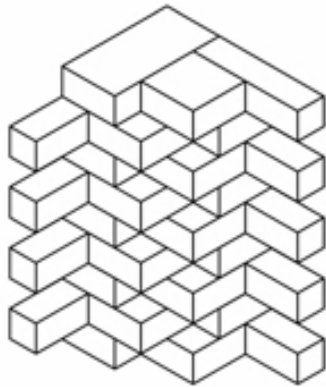

design

basic rule

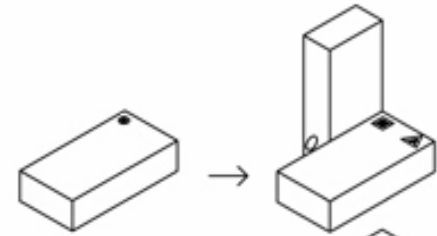

ornament rules

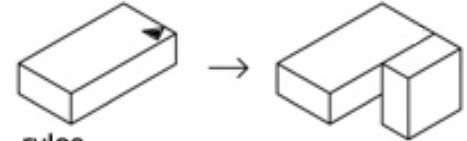
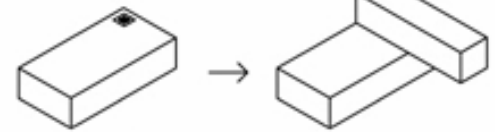

rules

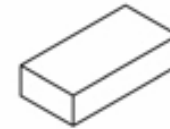

initial shape

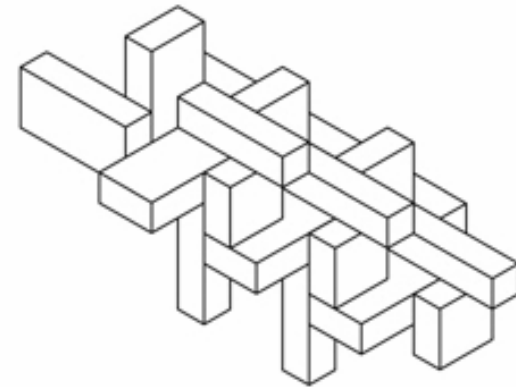

design

ADDITIVE GRAMMARS
ornamentation rules

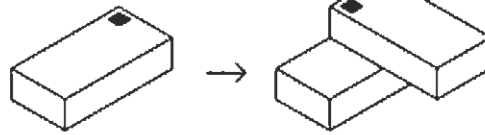
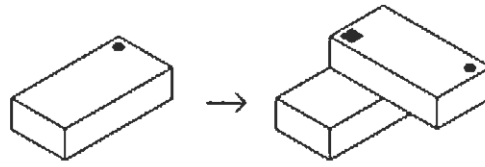

rules

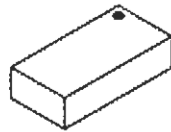

initial shape

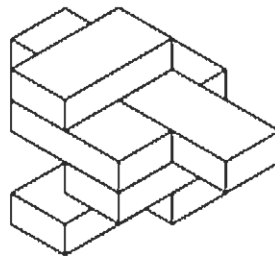

design

ADDITIVE GRAMMAR
recursive ornamentation rule

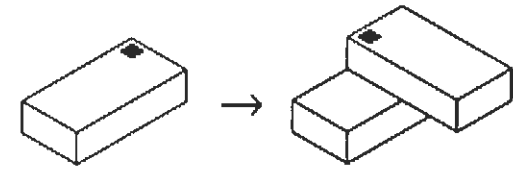
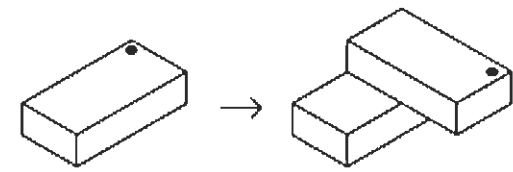
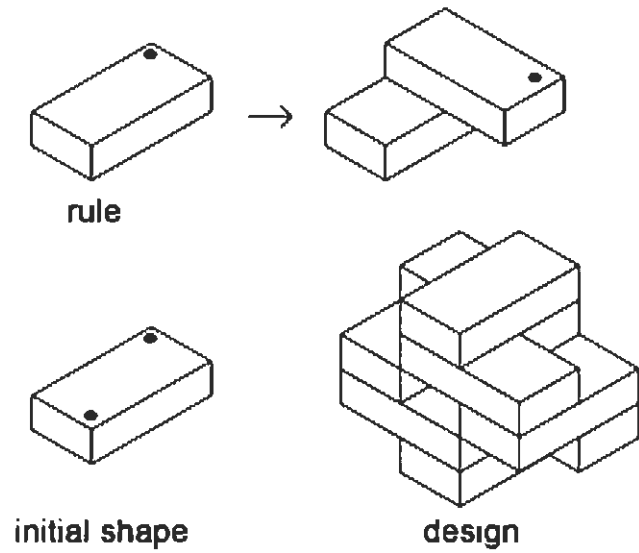

rules

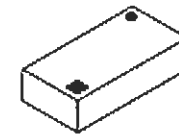

initial shape

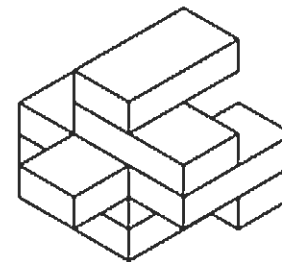

design

ADDITIVE GRAMMARS
initial shapes with multiple labels

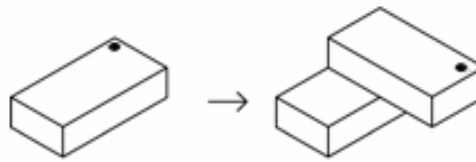

rule

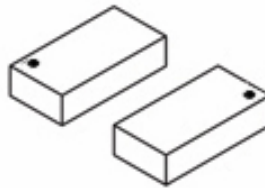

initial shape

?

design

ADDITIVE GRAMMARS

multiple initial shapes

Hierarchy of shape grammars

basic grammars

nondeterministic basic grammars

additive grammars

❖ unrestricted grammars

Unrestricted shape grammar

A set of addition rules, subtraction rules, and/or addition/subtraction rules labeled in any way

Initial shape: any shape labeled in any way